

dalby

Wooden Leg Coffee and Cafe Table

INNER / SPACE

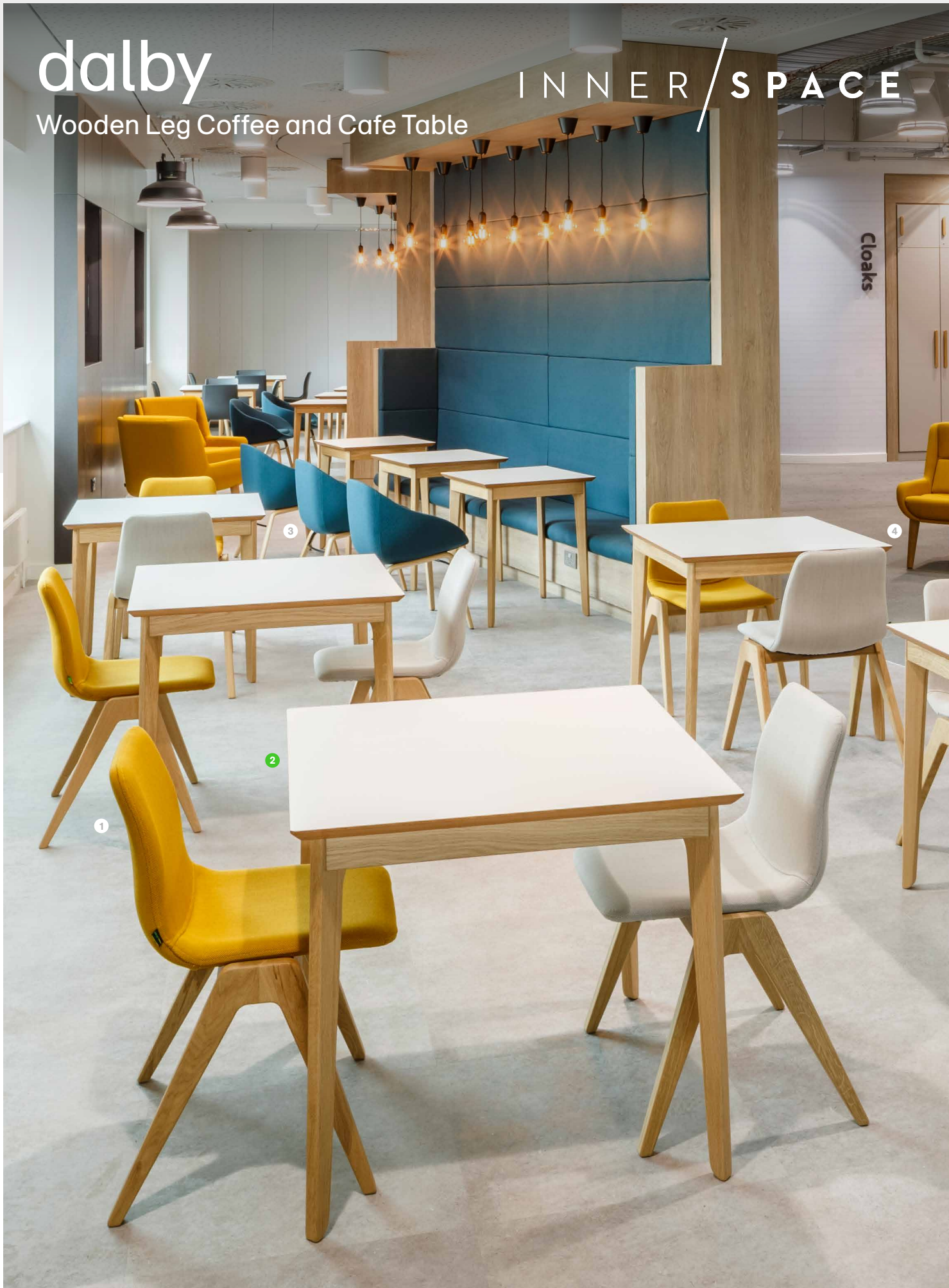

About Dalby

As your newest old friend, the Dalby table will effortlessly inject warmth and quality into an interior. Dalby provides a practical and robust surface making it ideal for the hospitality industry, or the home. Built from solid materials, Dalby will last as long as it's timeless aesthetic endures.

Compliance

- SCS Indoor Advantage™ Gold Certificate
- FSC® certified products available upon request
- naughtone is FISP and ISO14001 certified
- Our tables are designed to meet or exceed all EN performance requirements per BS EN 15372:2016

Sizes

All dimensions quoted are rounded to the nearest 5mm or nearest 1/2 inch



DAL650DL
Dalby 650 Circular Coffee Table
mm Dia 650 H 350
inch Dia 25.5 H 14



DAL650SL
Dalby 650 Square Coffee Table
mm W 650 D 650 H 350
inch W 25.5 D 25.5 H 14



DAL850DL
Dalby 850 Circular Coffee Table
mm Dia 850 H 350
inch Dia 33.5 H 14



DAL850SL
Dalby 850 Square Coffee Table
mm W 850 D 850 H 350
inch W 33.5 D 33.5 H 14



DAL11X55L
Dalby Rectangular Coffee Table
mm W 1100 D 550 H 350
inch W 43.5 D 21.5 H 14



DAL350D
Dalby 350 Circular Side Table
mm Dia 350 H 550
inch Dia 14 H 21.5



DAL350S
Dalby 350 Square Side Table
mm W 350 D 350 H 550
inch W 14 D 14 H 21.5



DAL650S
Dalby 650 Square Cafe Table
mm W 650 D 650 H 750
inch W 25.5 D 25.5 H 29.5



DAL850D
Dalby 850 Circular Cafe Table
mm Dia 850 H 750
inch Dia 33.5 H 29.5

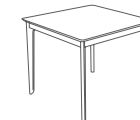

DAL850S
Dalby 850 Square Cafe Table
mm W 850 D 850 H 750
inch W 33.5 D 33.5 H 29.5

Base Finishes

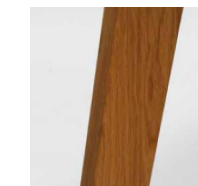

Solid Oak
Matt lacquered

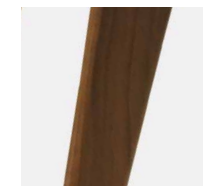

Walnut
Matt lacquered

Top Options



White / Black MFMDF
edge banded



White / Black MFMDF
with reverse chamfer,
polished MDF edge



Forbo Lino
with reverse chamfer edge
8 colours available



Oak Veneer
with reverse chamfer,
polished MDF edge



Walnut Veneer
with reverse chamfer,
polished MDF edge



White Carrara Marble
with reverse chamfer
Coffee tables only

dalby

Wooden Leg Table



About Dalby

















As your newest old friend, the Dalby table will effortlessly inject warmth and quality into an interior. Dalby provides a practical and robust surface making it ideal for the hospitality industry, or the home. Built from solid materials, Dalby will last as long as it's timeless aesthetic endures.

Compliance

- SCS Indoor Advantage™ Gold Certificate
- FSC® certified products available upon request
- naughtone is FISP and ISO14001 certified
- Our tables are designed to meet or exceed all EN performance requirements per BS EN 15372:2016

Sizes

All dimensions quoted are rounded to the nearest 5mm or nearest 1/2 inch

 DAL12DIA Dalby 1200 Circular Table mm Dia 1200 H 750 inch Dia 47.5 H 29.5	 DAL14DIA Dalby 1400 Circular Table mm Dia 1400 H 750 inch Dia 55 H 29.5	 DAL16DIA Dalby 1600 Circular Table mm Dia 1600 H 750 inch Dia 63 H 29.5
 DAL16X8 Dalby 1600x800 Table mm W 1600 D 800 H 750 inch W 63 D 31.5 H 29.5	 DAL18X8 Dalby 1800x800 Table mm W 1800 D 800 H 750 inch W 71 D 31.5 H 29.5	 DAL20X9 Dalby 2000x900 Table mm W 2000 D 900 H 750 inch W 79 D 35.5 H 29.5
 DAL22X9 Dalby 2200x900 Table mm W 2200 D 900 H 750 inch W 87 D 35.5 H 29.5	 DAL24X10 Dalby 2400x1000 Table mm W 2400 D 1000 H 750 inch W 94.5 D 39.5 H 29.5	 DAL24X12 Dalby 2400x1200 Table mm W 2400 D 1200 H 750 inch W 94.5 D 47.5 H 29.5
 DAL28X12 Dalby 6 Leg Table 2800 mm W 2800 D 1200 H 750 inch W 110 D 47.5 H 29.5	 DAL32X12 Dalby 6 Leg Table 3200 mm W 3200 D 1200 H 750 inch W 126 D 47.5 H 29.5	
 DAL16BH Dalby Bar Height Table 1600 mm W 1600 D 800 H 1000 inch W 63 D 31.5 H 39	 DAL18BH Dalby Bar Height Table 1800 mm W 1800 D 800 H 1000 inch W 71 D 31.5 H 39	 DAL20BH Dalby Bar Height Table 2000 mm W 2000 D 900 H 1000 inch W 79 D 35.5 H 39
 DAL22BH Dalby Bar Height Table 2200 mm W 2200 D 900 H 1000 inch W 87 D 35.5 H 39	 DAL28BH Dalby 6 Leg Bar Height Table 2800 mm W 2800 D 1200 H 1000 inch W 110 D 47.5 H 39	 DAL32BH Dalby 6 Leg Bar Height Table 3200 mm W 3200 D 1200 H 1000 inch W 126 D 47.5 H 39

Base Finishes

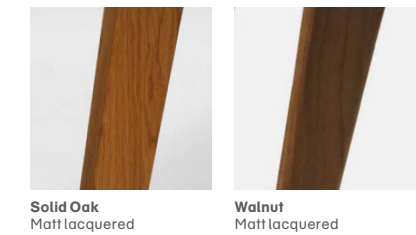

Top Options

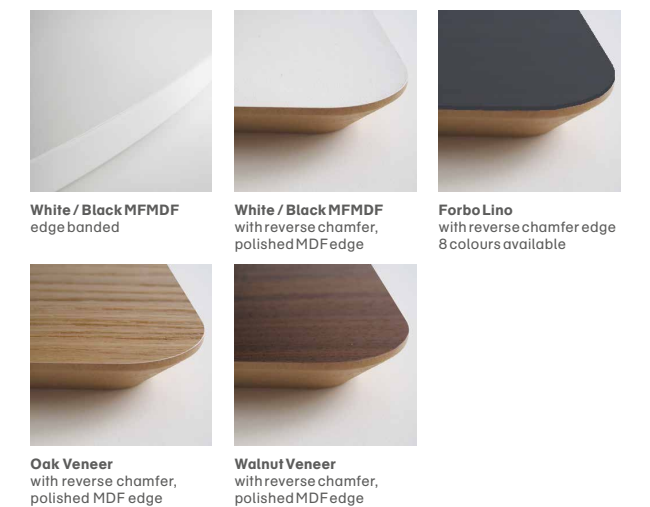

Power and Data Options

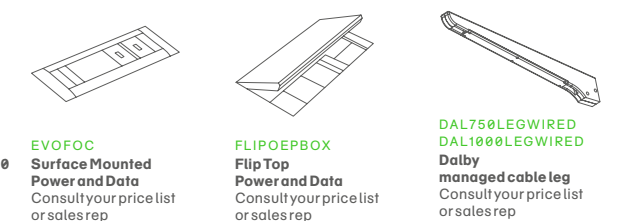

INNER / SPACE





INNER / SPACE



INNER / SPACE



INNER / SPACE

Dalby Table Technical Specifications

Testing

Our tables are designed to meet or exceed all EN performance requirements per **EN 15372:2008**, which includes the following tests:

- Edges of top rounded or chamfered, no burrs or sharp edges
- Shall not be possible for load bearing parts to come loose unintentionally
- Shear and squeeze points during use
- Stability under vertical force – Main surface
- Horizontal static load – High
- Vertical static load
- Horizontal fatigue
- Vertical impact for tables without glass

Structural Testing Certifications

DAL850DL
Dalby 850 circular coffee table
BS EN 15372:2008, Level 2
Static load 120kg

Servicing



If a component is damaged and needs replacing then please email our team with an image of the damaged part and reference your order number, we will be happy to facilitate any replacements.

Warranty



naughtone offers a **7 Year** warranty across all products. Details on the terms and conditions of naughtones warranty can be found at naughtone.com/warranty

Dalby Coffee Table Technical Specifications

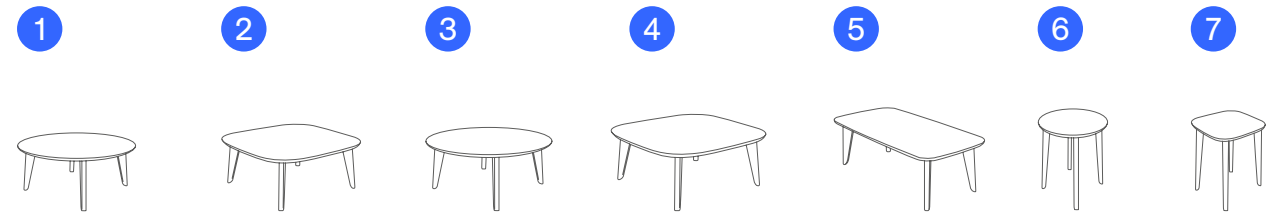

Product Code and Description <small>All dimensions quoted are rounded to the nearest 5mm or nearest 1/2 inch</small>	A Overall Width	B Overall Depth	C Overall Height	D Weight
1 DAL650DL Dalby 650 Circular Coffee Table	650 mm 25.5 in	650 mm 25.5 in	350 mm 14 in	13.7 kg 30.2 lbs
2 DAL650SL Dalby 650 Square Coffee Table	650 mm 25.5 in	650 mm 25.5 in	350 mm 14 in	13.7 kg 30.2 lbs
3 DAL850DL Dalby 850 Circular Coffee Table	850 mm 33.5 in	850 mm 33.5 in	350 mm 14 in	19.3 kg 42.5 lbs
4 DAL850SL Dalby 850 Square Coffee Table	850 mm 33.5 in	850 mm 33.5 in	350 mm 14 in	19.3 kg 42.5 lbs
5 DAL11X55 Dalby Rectangular Coffee Table	1100 mm 43.5 in	550 mm 21.5 in	350 mm 14 in	20.5 kg 40.2 lb
6 DAL350D Dalby Side Table	350 mm 14 in	350 mm 14 in	550 mm 21.5 in	6.4 kg 14.1 lbs
7 DAL350S Dalby Square Side Table	350 mm 14 in	350 mm 14 in	550 mm 21.5 in	6.4 kg 14.1 lbs

Measuring Guide

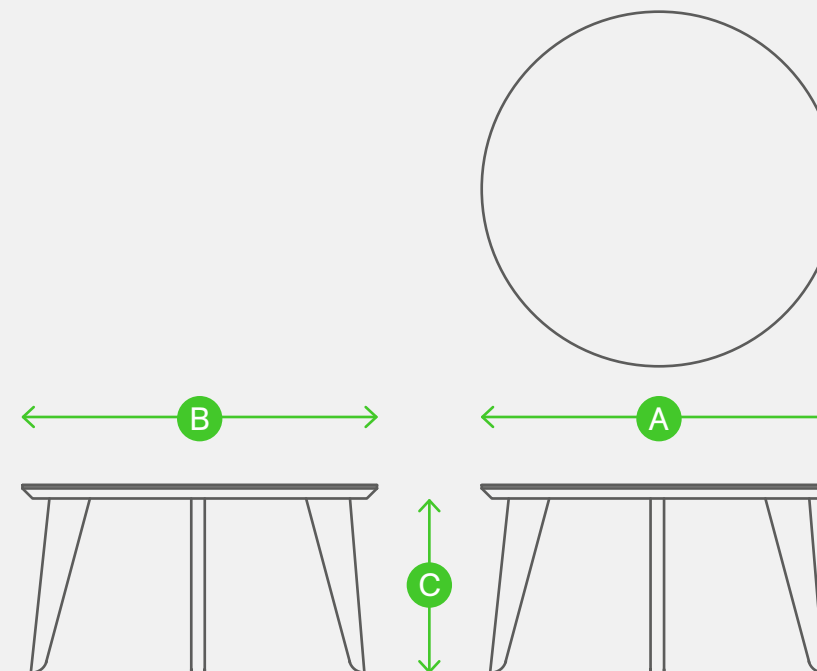

Dalby Cafe Table Technical Specifications



Product Code and Description <small>All dimensions quoted are rounded to the nearest 5mm or nearest 1/2 inch</small>	A Overall Width	B Overall Depth	C Overall Height	D From Floor to Beam	E Distance between Legs (front)	F Distance between Legs (side)	G Weight
8 DAL650S Dalby Square Cafe Table	650mm 25.5in	650mm 25.5in	750mm 29.5in	660mm 26in	455mm 18in	455mm 18in	20.9kg 46.1lbs
9 DAL650D Dalby Circular Cafe Table	650mm 25.5in	650mm 25.5in	750mm 29.5in	660mm 26in	525mm 21in	525mm 21in	27.7kg 61lbs
10 DAL850S Dalby Square Cafe Table	850mm 33.5in	850mm 33.5in	750mm 29.5in	660mm 26in	655mm 26in	655mm 26in	28.4kg 62.6lbs

Measuring Guide

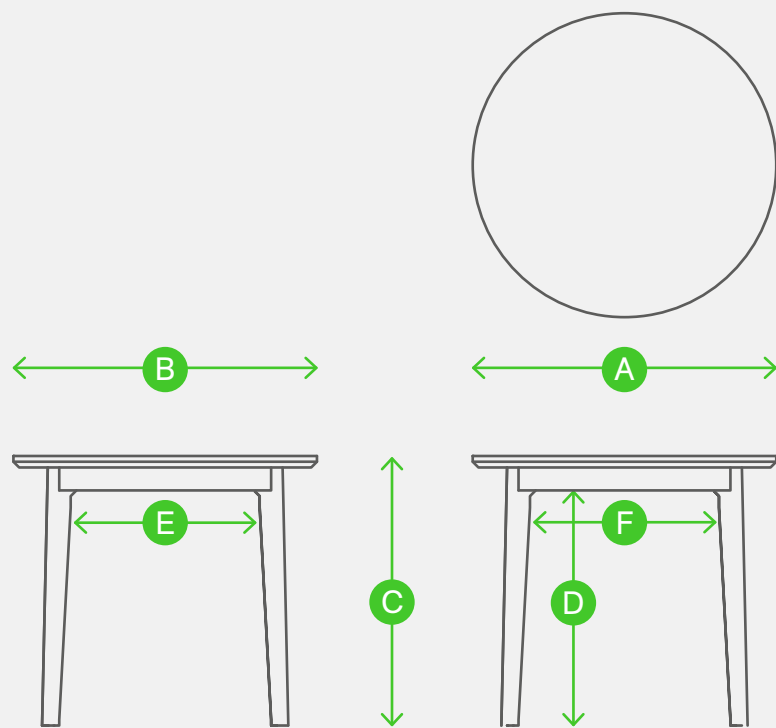

Dalby Standard Circular Table Technical Specifications



Product Code and Description <small>All dimensions quoted are rounded to the nearest 5mm or nearest 1/2 inch</small>	A Overall Width	B Overall Depth	C Overall Height	D From Floor to Beam	E Distance between Legs	F Weight
11 DAL12DIA Dalby 1200 Circular Table	1200mm 47.5in	1200mm 47.5in	750mm 29.5in	645mm 25.4in	650mm 25.5in	43.6kg 96.1lbs
12 DAL14DIA Dalby 1200 Circular Table	1400mm 55in	1400mm 55in	750mm 29.5in	645mm 25.4in	850mm 33.5in	50.4kg 111.1lbs
13 DAL16DIA Dalby 1200 Circular Table	1600mm 63in	1600mm 63in	750mm 29.5in	645mm 25.5in	1050mm 41.5in	61.2kg 134.9lbs

Measuring Guide

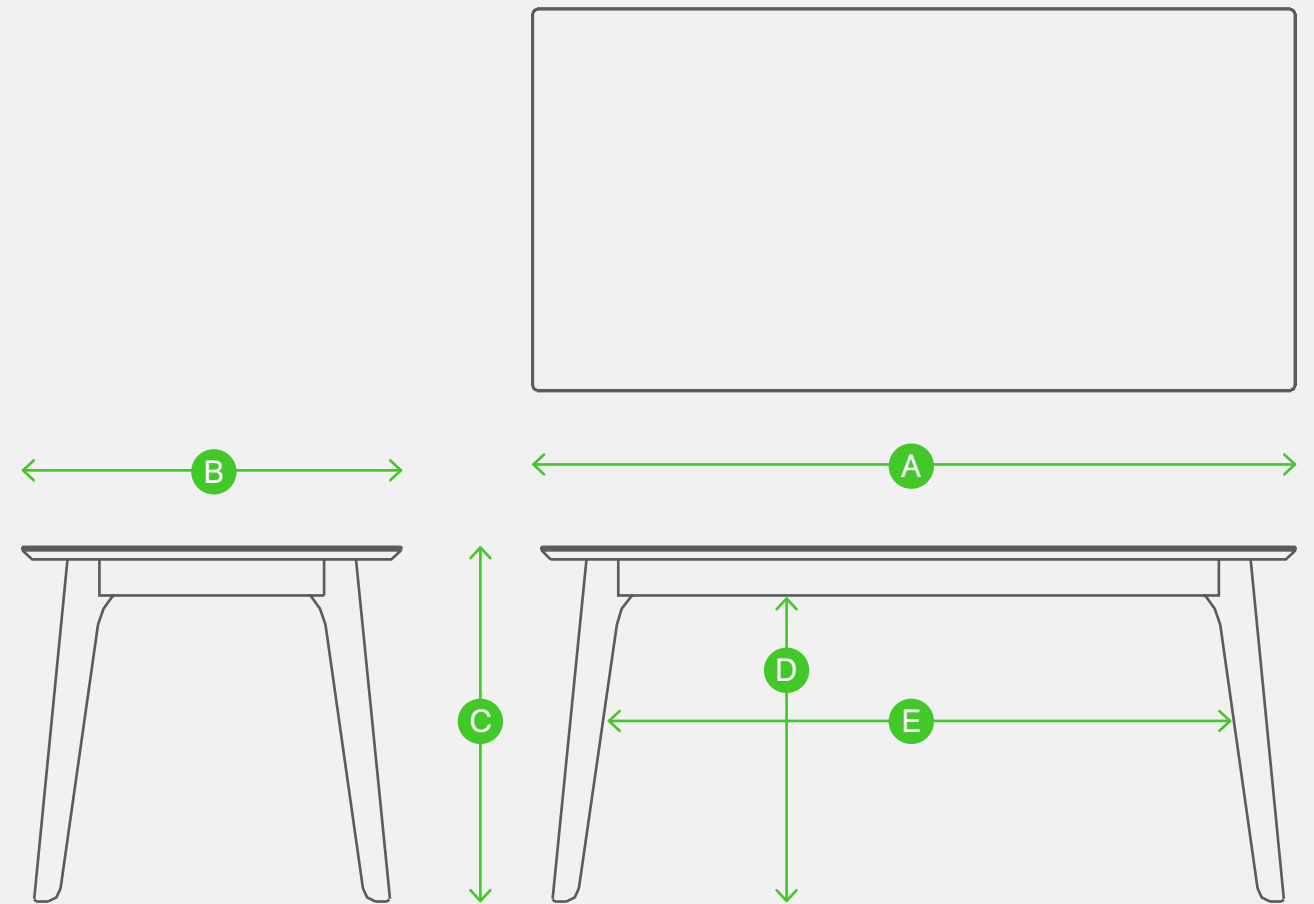

Dalby Standard Rectangular Table Technical Specifications



Product Code and Description <small>All dimensions quoted are rounded to the nearest 5mm or nearest 1/2 inch</small>	A Overall Width	B Overall Depth	C Overall Height	D From Floor to Beam	E Distance between Legs (front)	F Distance between Legs (side)	G Weight
14 DAL16X8 Dalby 1600 x 800 Table	1600mm 63in	800mm 31.5in	750mm 29.5in	645mm 25.4in	1360mm 53.5in	560mm 22in	46.2kg 101.9lbs
15 DAL18X8 Dalby 1800 x 800 Table	1800mm 71in	800mm 31.5in	750mm 29.5in	645mm 25.4in	1560mm 61.5in	560mm 22in	48.5kg 106.9lbs
16 DAL20X9 Dalby 2000 x 900 Table	2000mm 79in	900mm 35.5in	750mm 29.5in	645mm 25.4in	1760mm 69.5in	660mm 25.6in	58.3kg 128.5lbs
17 DAL22X9 Dalby 2200 x 900 Table	2200mm 87in	900mm 35.5in	750mm 29.5in	645mm 25.4in	1960mm 77in	660mm 25.6in	61.6kg 135.8lbs
18 DAL24X10 Dalby 2400 x 1000 Table	2400mm 95in	1000mm 39in	750mm 29.5in	645mm 25.4in	2160mm 85in	760mm 30in	63.5kg 140lbs
19 DAL24X12 Dalby 2400 x 1200 Table	2400mm 95in	1200mm 47.5in	750mm 29.5in	645mm 25.4in	2360mm 93in	960mm 38in	80.5kg 177.6lb
20 DAL28X12 Dalby 6 Leg Table 2800	2800mm 110in	1200mm 47.5in	750mm 29.5in	645mm 25.4in	2760mm 109in	1360mm 53.5in	107.2kg 236.4lb
21 DAL32X12 Dalby 6 Leg Table 3200	3200mm 126in	1200mm 47.5in	750mm 29.5in	645mm 25.4in	3160mm 125.5in	1760mm 69.5in	112.2kg 247.5lb

Measuring Guide

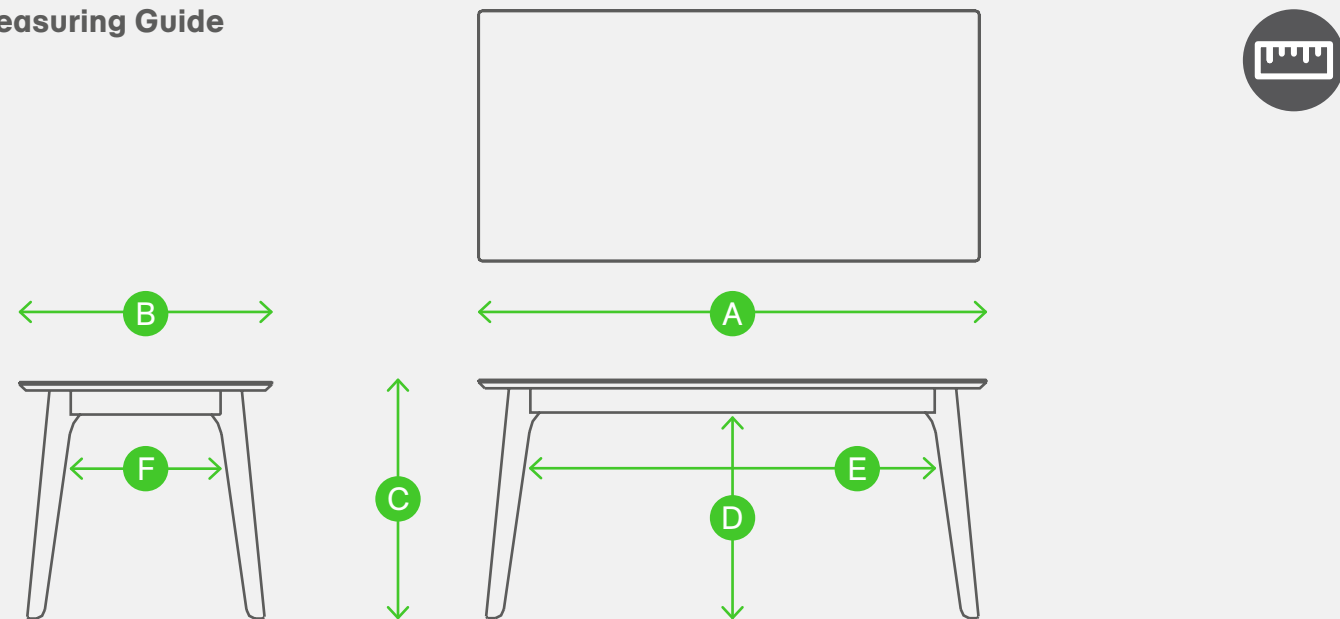

Dalby Bar Height Table Technical Specifications

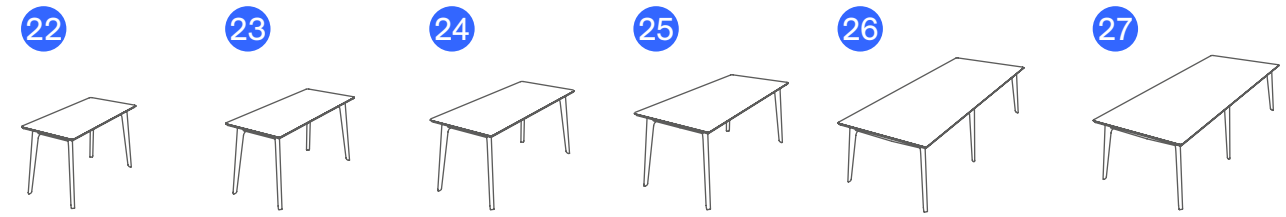

Product code and description	A Overall Width	B Overall Depth	C Overall Height	D From Floor to Beam	E Distance between legs (front)	F Distance between legs (side)	G Weight
22 DAL16BH Dalby Bar Height Table 1600	1600mm 63in	800mm 31.5in	1000mm 39in	895mm 35.2in	1360mm 53.5in	560mm 22in	63.2kg 139.2lbs
23 DAL18BH Dalby Bar Height Table 1800	1800mm 71in	800mm 31.5in	1000mm 39in	895mm 35.2in	1560mm 61.5in	560mm 22in	44.9kg 98.9lbs
24 DAL20BH Dalby Bar Height Table 2000	2000mm 79in	900mm 35.5in	1000mm 39in	895mm 35.2in	1760mm 69.5in	660mm 25.6in	52.4kg 115.5lbs
25 DAL22BH Dalby Bar Height Table 2200	2200mm 87in	900mm 35.5in	1000mm 39in	895mm 35.2in	1960mm 77in	660mm 25.6in	65.3kg 144.0lbs
26 DAL28BH Dalby 6 Leg Bar Height Table 2800	2800mm 110in	1200mm 47.5in	1000mm 39in	895mm 35.2in	2760mm 109in	1360mm 53.5in	104.1kg 229.5lbs
27 DAL32BH Dalby 6 Leg Bar Height Table 3200	3200mm 126in	1200mm 47.5in	1000mm 39in	895mm 35.2in	3160mm 125.5in	1760mm 69.5in	120.2kg 264.9lbs

Measuring Guide

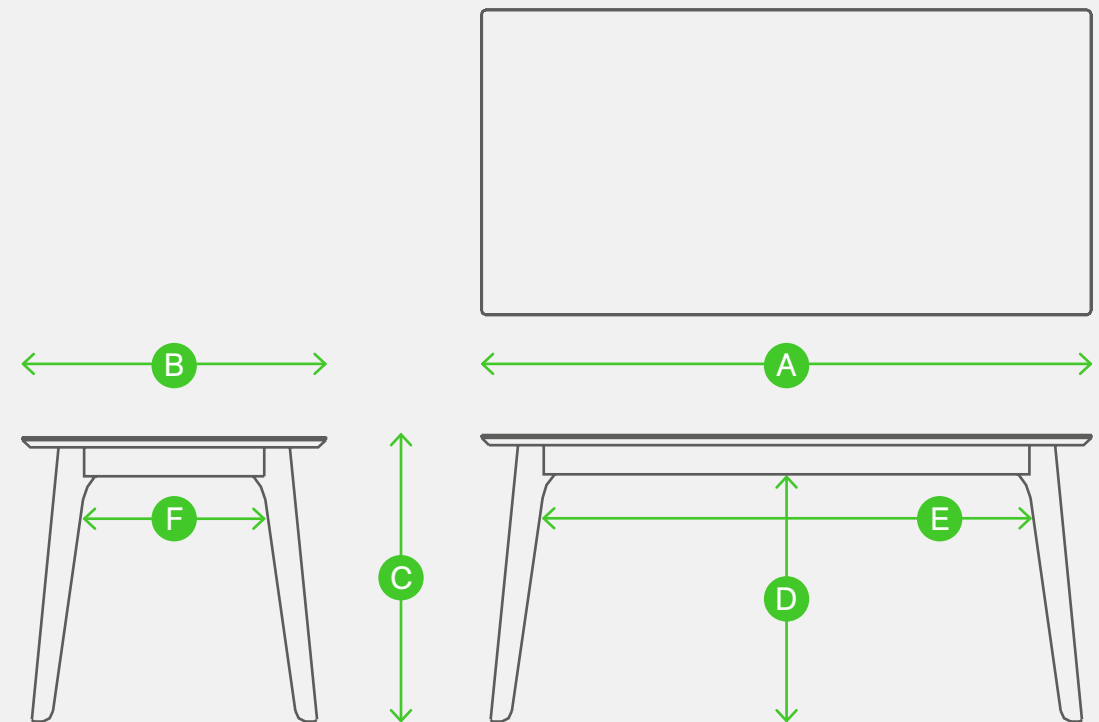

Dalby Table Environmental Product Summary



Environment Attributes

- naughtone is **FISP** and **ISO14001** certified
- naughtone is **FSC®** certified
- **39.85kg** total weight
- **14.3% Recyclable** (top plates and fixings)
- **85.7% Reusable** (top, legs and brackets)
- **26.83% Recycled Content** (brackets, fixings and beams)
- Packaging: **94.6%** recycled cardboard **5.4%** virgin fibre and protective biodegradable bubble wrap
- **Indoor Advantage™ Gold** ANSI/BIFMA Furniture Emissions Standard (M7.1/X7.1-2011 R2016) and ANSI/BIFMA e-3-2014e (Credits 7.6.1, 7.6.2, 7.6.3)

These attributes can help you to achieve criteria towards **LEED, BREEAM, Ska** and **WELL** building certifications



Dalby Table Environmental Product Summary

Material Percentage Split

- 63.13% Melamine Faced MDF
- 13.67% Stainless Steel
- 12.90% Solid Oak
- 9.71% Veneered MDF
- 0.42% Mild Steel Zinc Plated
- 0.19% Mild Steel

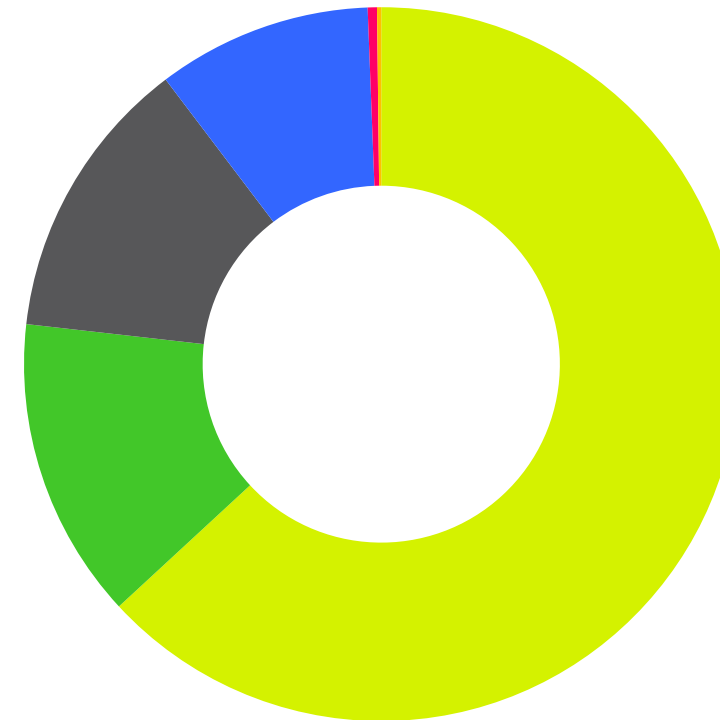

Post Consumer Recycled Content

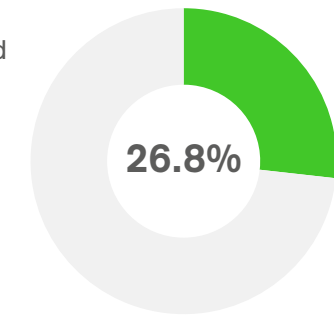

Recyclable Content

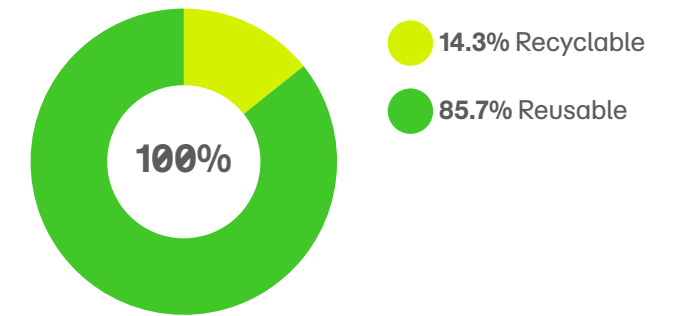

Product Specific Design Statement

The Dalby table is available in a range of shapes, sizes and finishes but for the purpose of this document we have a specific example from the range:

Dalby table 1600x800 with white MFMDf top

Dalby table legs are CNC cut from solid oak and hand finished before being matt lacquered.

The beams are oak veneered and matt lacquered to match. The table frame is component based and is delivered fully disassembled for efficient delivery and installation. The top is CNC cut and the MDF edge is then matt lacquered.

CSR Statement

naughtone has always considered the environment throughout our design and manufacturing process. We understand that as we continue to grow, so does our potential impact on our surroundings. As most of our raw materials are simple, we have great control over their sources, and are proud to be able to offer **FSC®certified** upholstered products and use recycled metals in our table ranges. The addition of our North American manufacturing provision also helps to keep manufacturing miles to a minimum, as our market continues to grow in the USA. Finally, naughtone offers a 'bring back' programme, where the client is able to return the product to our factory, where we will be happy to breakdown and recycle the parts for you.

Where sustainable sources are quoted, and a chain of custody is required by a customer this must be indicated on the purchase order to naughtone. A chain of custody requested after an order has been placed or delivered may be difficult to recover.

Figures stated in the Environmental product summary may vary based on model and options selected, we have based this document on a specific example when produced in the United Kingdom. Recycled content calculations are taken from supplier information and industry averages, material variables are likely to affect the figures which may result in higher or lower percentages.

This document will be reviewed and updated periodically and is subject to change without notice.



FSC® certified products available upon request



naughtone offers PEFC certified products





1 Design

Every aspect of the naughtone product ranges has been designed with the environment considered, from ethical material choice and production efficacy to storage efficiency and ease of disassembly.

Dense foam sets and resilient fabrics are selected for their longevity and effectiveness across sectors. Durable high quality finishes such as powder coated bases in a range of colours allow clients the freedom of finish options. Finish samples are available allowing clients to make informed decisions and retain to add to their finish libraries for future reference.

2 Raw Material

Local supply of raw materials is employed for the production of our products when possible, procured from suppliers that are quality inspected for extraction methods and meet the highest environmental standards.

3 Production

As many of our products are assembled by hand the energy expenditure wasted from machinery during the production process is kept to a minimum.

All fabrics are cut to ensure optimum efficiency with fabric usage and reduced waste consumption per unit.

All production sites have recycling facilities for any excess product that cannot be used elsewhere, which is then managed by a professional third party.

4 Distribution

Distribution of naughtone products generally occurs directly between the manufacturing site to the client. Production is localised when possible to the US or UK regions, reducing the carbon footprint and miles travelled for each product.

Many items are flat packed for delivery or shipped disassembled with efficient, minimised packaging; optimizing the transportation vessel space.

5 Usage

naughtone products do not require energy or water to function, thus no environmental exchange takes place and no waste is generated during the life of the product.

The only foreseeable need is the cleaning of the product for general maintenance. This includes regular vacuuming to remove dirt and dust particles on upholstery items, and using a dry or damp cloth to wipe non-upholstery items.

This is recommended for all products utilised under conditions of normal wear and is expected to have negligible environmental impacts.

6 End of Life

Although our products are durable and demonstrate timeless design, naughtone products are manufactured in such a way that they can be easily disassembled at the end of life and most of the componentry can be either recycled or re-used as applicable.

As a company we are also happy to accept the return of products, to help re-home or recycle furniture or components at the end of the products useful life.

INNER / SPACE

14 textile crescent, salisbury q 4107
P: 07 3216 6079
E: sales@innerspace.net.au